

# MULTI-MOUNT SERIES CONNECTOR

**Multi-Mount couplings** provide one easy-to-use coupling for connecting from three to five lines at once. Multi-mount couplings are available in a wide variety of materials including acetal and chrome-plated brass. Multi-mounts are keyed to prevent mismatched connections and can be configured with or without valves for maximum design flexibility.



## SPECIFICATIONS

### PRESSURE:

**Minimum:** Vacuum

**Maximum:** Brass = 500 psi / no. of stations  
or Acetal = 240 psi / no. of stations

### TEMPERATURE:

-40°F to 180°F (-40°C to 82°C)

### MATERIALS:

**Main components:** Acetal or chrome-plated brass

**Thumb latch:** Stainless steel

**Mounting Plate:** Black anodized aluminum

**Valves:** Acetal

**Valve spring:** 316 stainless steel

**External springs and pin:** Stainless steel

**O-ring:** Buna-N

### TUBING SIZES:

1/8" to 3/8" ID, 3.2mm to 9.5mm ID

### FEATURES

- Three to five line connection → Fast, efficient operation
- Separate flow paths → Pressure and/or vacuum in one coupling
- Insert is keyed to body → Ensures correct line orientation
- Acetal or chrome-plated brass → Maximize design flexibility

### BENEFITS

## FOUR-STEP MULTI-MOUNT ORDERING PROCESS

**STEP 1:** Determine flow size and termination type.

**STEP 2:** Order two "multiple mount plates" (one for the coupling bodies and one for the coupling inserts) with the appropriate number of connection stations for your specific application (available in 3, 4, or 5 connections, or construct your own). Refer to page 108-109.

**STEP 3:** Order two "standard panel mount coupling bodies with thumb latches" for the exterior stations.

**STEP 4:** Order an appropriate number of "multiple mount coupling bodies without thumb latches" to accommodate the remaining interior stations.

**STEP 5:** Order an appropriate number of "multiple mount inserts" to connect with standard and multiple mount bodies.



SCAN

[cpcworldwide.com/Multi-mount](http://cpcworldwide.com/Multi-mount)

### STEP 3

Multiple mount coupling bodies for interior stations

### STEP 2

Standard panel mount coupling bodies with thumb latch for exterior stations

### STEP 1

Multiple mount plates

### STEP 4

Multiple mount coupling inserts

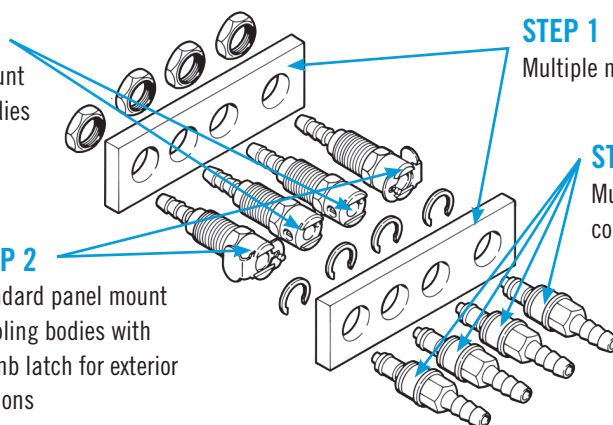

**COLDER PRODUCTS COMPANY**  
U.S.A.  
PHONE: +1 (651) 645-0091  
FAX: +1 (651) 645-5404  
TOLL FREE: +1 (800) 444-2474  
E-MAIL: [info@cpcworldwide.com](mailto:info@cpcworldwide.com)

**COLDER PRODUCTS COMPANY GMBH**  
Germany  
E-MAIL: [cpcgmbh@cpcworldwide.com](mailto:cpcgmbh@cpcworldwide.com)

**DOVER (SHANGHAI) INDUSTRIAL CO., LTD**  
ShangHai, China  
PHONE: +86 21 2411 2666  
TOLL FREE: +86 400 990 1978  
E-MAIL: [asiapacific@cpcworldwide.com](mailto:asiapacific@cpcworldwide.com)

# UNMATCHED CUSTOMIZATION CAPABILITIES



**For more than 35 years, CPC engineers** have worked with customers worldwide to design application-specific solutions that resolve their fluid handling-related challenges and improve product performance. We can do the same for you.

## APPLICATIONS FOR IDENTIQUIK® COUPLINGS INCLUDE:

- Weight, pressure, temperature and flow sensing
- Bulkhead mount readers
- Multiplexing technology
- Custom interface
- Larger tag memory sizes
- Additional security features



[cpcworldwide.com/iMAR](https://cpcworldwide.com/iMAR)

# MULTI-MOUNT SERIES DIMENSIONS

## MULTIPLE MOUNT PLATES



NUMBER OF STATIONS	1/8" FLOW SIZE	LENGTH	1/4" FLOW SIZE	LENGTH
3	CP103	2.6 (66.04)	LCP103	3 (76.2)
4	CP104	3.35 (85.09)	LCP104	3.35 (85.09)
5	CP105	4.1 (104.14)	LCP105	4.9 (124.46)

## RETAINING RINGS

COUPLING SERIES	PART NO. (REPLACEMENTS)
MC/PMC	101700
LC/PLC	278100

## COUPLING BODIES - Acetal

Information in RED indicates 1/8" flow couplings. These are not compatible with 1/4" flow couplings in non-shaded sections.



TERMINATION	TUBING/THREAD SIZE	METRIC EQ.	STRAIGHT THRU	SHUTOFF	A	B	D
PANEL MOUNT FERRULELESS POLYTUBE FITTING, PTF†	1/4" OD, 0.17" ID	6.4mm OD, 4.3mm ID	PMM1204	PMMD1204	0.72 (18.3)	1.72 (43.7)	
	1/4" OD, 0.17" ID	6.4mm OD, 4.3mm ID	PLM12004	PLMD12004	0.94 (23.9)	1.82 (46.2)	
	3/8" OD, 0.25" ID	9.5mm OD, 6.4mm ID		PLMD12006	0.94 (23.9)	1.95 (49.5)	
PANEL MOUNT HOSE BARB	1/8" ID	3.2mm ID	PMM1602	PMMD1602	0.72 (18.3)	1.65 (41.9)	
	3/16" ID	4.8mm ID	PMM1603	PMMD1603	0.72 (18.3)	1.85 (47.0)	
	1/4" ID	6.4mm ID	PMM1604	PMMD1604	0.72 (18.3)	1.85 (47.0)	
	1/4" ID	6.4mm ID	PLM16004	PLMD16004	0.94 (23.9)	1.95 (49.5)	
	5/16" ID	7.9mm ID	PLM16005	PLMD16005	0.94 (23.9)	1.95 (49.5)	
	3/8" ID	9.5mm ID		PLMD16006	0.94 (23.9)	1.95 (49.5)	
PANEL MOUNT FEMALE THREAD	10-32 UNF		PMM181032	PMMD181032	0.72 (18.3)	1.25 (31.8)	

## COUPLING INSERTS - Acetal





TERMINATION	TUBING/THREAD SIZE	METRIC EQ.	STRAIGHT THRU	SHUTOFF	A	B	D
IN-LINE FERRULELESS POLYTUBE FITTING, PTF†	5/32" OD, 0.10" ID	4.0mm OD, 2.5mm ID	PMM20025	PMMD20025	0.58 (14.7)	1.86/1.96 (47.2/49.8)	
	1/4" OD, 0.17" ID	6.4mm OD, 4.3mm ID	PMM2004	PMMD2004	0.58 (14.7)	1.77/1.87 (45.0/47.5)	
	1/4" OD, 0.17" ID	6.4mm OD, 4.3mm ID	PLM20004	PLMD20004	0.72 (18.3)	2.10/2.23 (53.3/56.6)	
	3/8" OD, 0.25" ID	9.5mm OD, 6.4mm ID		PLMD20006	0.72 (18.3)	2.02/2.15 (51.3/54.6)	
IN-LINE HOSE BARB	1/8" ID	3.2mm ID	PMM2202	PMMD2202	0.56 (14.2)	1.87/1.97 (47.5/50.0)	
	3/16" ID	4.8mm ID	PMM2203	PMMD2203	0.58 (14.7)	2.08/2.18 (52.8/55.4)	
	1/4" ID	6.4mm ID	PMM2204	PMMD2204	0.58 (14.7)	1.83/1.93 (46.5/49.0)	
	1/4" ID	6.4mm ID	PLM22004	PLMD22004	0.72 (18.3)	2.20/2.33 (55.9/59.2)	
	5/16" ID	7.9mm ID	PLM22005	PLMD22005	0.72 (18.3)	2.20/2.33 (55.9/59.2)	
	3/8" ID	9.5mm ID	PLM22006	PLMD22006	0.72 (18.3)	2.03/2.16 (51.6/54.9)	
ELBOW FERRULELESS POLYTUBE FITTING, PTF†	1/4" OD, 0.17" ID	6.4mm OD, 4.3mm ID	PMM2104	PMMD2 104	0.53 (13.5)	1.41/1.51 (35.8/38.4)	0.77 (19.6)

All measurements are in inches (millimeters) unless otherwise noted. Tubing must meet stated inside and outside diameters. Couplings are pictured with valves unless otherwise noted.

†NOTE: CPC's Ferruleless Polytube Fitting terminations do not require ferrules to achieve a secure connection, which makes them easier to use and reuse. PTF fittings are designed for semi-rigid tubing, i.e., polyethylene, nylon, polyurethane, etc.

## COUPLING BODIES - Chrome Plated Brass

TERMINATION	TUBING/THREAD SIZE	METRIC EQ.	STRAIGHT THRU	SHUTOFF	A	B	D
 <b>PANEL MOUNT FERRULELESS POLYTUBE FITTING, PTF†</b>	1/4" OD, 0.17" ID	6.4mm OD, 4.3mm ID	MM1204	MMD1204	0.72 (18.3)	1.72 (43.7)	
	1/4" OD, 0.17" ID	6.4mm OD, 4.3mm ID		LMD12004	0.94 (23.9)	1.82 (46.2)	
	3/8" OD, 0.25" ID	9.5mm OD, 6.4mm ID	LM12006	LMD12006	0.94 (23.9)	1.95 (49.5)	
 <b>PANEL MOUNT HOSE BARB</b>	1/8" ID	3.2mm ID	MM1602	MMD1602	0.72 (18.3)	1.65 (41.9)	
	3/16" ID	4.8mm ID	MM1603	MMD1603	0.72 (18.3)	1.85 (47.0)	
	1/4" ID	6.4mm ID	LM16004	LMD16004	0.94 (23.9)	1.95 (49.5)	
	5/16" ID	7.9mm ID	LM16005	LMD16005	0.94 (23.9)	1.95 (49.5)	
	3/8" ID	9.5mm ID	LM16006	LMD16006	0.94 (23.9)	1.95 (49.5)	
 <b>PANEL MOUNT FEMALE THREAD</b>	10-32 UNF		MM181032		0.72 (18.3)	1.25 (31.8)	

## COUPLING INSERTS - Chrome Plated Brass

TERMINATION	TUBING/THREAD SIZE	METRIC EQ.	STRAIGHT THRU	SHUTOFF	A	B	D
 <b>IN-LINE FERRULELESS POLYTUBE FITTING, PTF†</b>	5/32" OD, 0.10" ID	4.0mm OD, 2.5mm ID	MM20025	MMD20025	0.58 (14.7)	1.86/1.96 (47.2/49.8)	
	1/4" OD, 0.17" ID	6.4mm OD, 4.3mm ID	MM2004	MMD2004	0.58 (14.7)	1.77/1.87 (45.0/47.5)	
	1/4" OD, 0.17" ID	6.4mm OD, 4.3mm ID	LM20004	LMD20004	0.72 (18.3)	2.10/2.23 (53.3/56.6)	
	3/8" OD, 0.25" ID	9.5mm OD, 6.4mm ID	LM20006	LMD20006	0.72 (18.3)	2.02/2.15 (51.3/54.6)	
 <b>IN-LINE HOSE BARB</b>	1/8" ID	3.2mm ID	MM2202	MMD2202	0.56 (14.2)	1.87/1.97 (47.5/50.0)	
	3/16" ID	4.8mm ID	MM2203	MMD2203	0.58 (14.7)	2.08/2.18 (52.8/55.4)	
	1/4" ID	6.4mm ID	MM2204	MMD2204	0.58 (14.7)	1.83/1.93 (46.5/49.0)	
	1/4" ID	6.4mm ID	LM22004	LMD22004	0.72 (18.3)	2.20/2.33 (55.9/59.2)	
	5/16" ID	7.9mm ID	LM22005	LMD22005	0.72 (18.3)	2.20/2.33 (55.9/59.2)	
	3/8" ID	9.5mm ID	LM22006	LMD22006	0.72 (18.3)	2.03/2.16 (51.6/54.9)	
 <b>ELBOW FERRULELESS POLYTUBE FITTING, PTF†</b>	1/4" OD, 0.17" ID	6.4mm OD, 4.3mm ID	MM2104		0.53 (13.5)	1.41/1.51 (35.8/38.4)	0.77 (19.6)

### PRODUCT DIMENSIONS

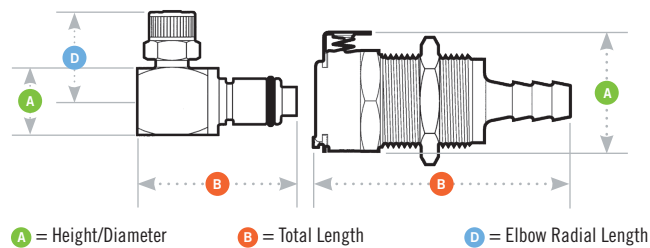

### PANEL DIMENSIONS

#### MM Series 1/8" Flow

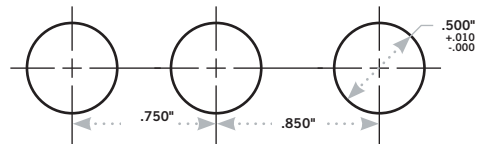

#### LM Series 1/4" Flow

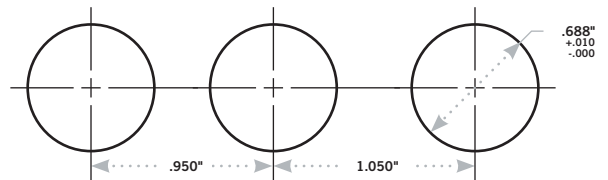

Multiple mount plates are keyed to prevent misconnections.

Multiple mount minimum coupling spacing: CPC offsets the last hole on the mounting plates so they cannot be misconnected.

WARRANTY: All sales are subject to Colder Products Company's limited express warranty set forth in the CPC catalog. Contact your local distributor or CPC Customer Service for warranty provisions.

Warning: Due to the wide variety of possible fluid media and operating conditions, unintended consequences may result from the use of this product, all of which are beyond the control of CPC. It is the user's responsibility to carefully determine and test for compatibility for use with their application. All such risks shall be assumed by the buyer.

COPYRIGHT © 2021 BY COLDER PRODUCTS COMPANY. COLDER PRODUCTS COMPANY, COLDER PRODUCTS AND CPC ARE REGISTERED

TRADEMARKS WITH THE US PATENT & TRADEMARK OFFICE